



PRODUCT INFORMATION

- _ level
- _ temperature
- _ pressure
- _ ...

FLOAT SWITCH BRASS

- Various electrical connections are possible
- Different possibilities of mounting
- Optional with adjustable switching points
- Sliding tube made of brass
- Up to five switching points, according to customer requirement

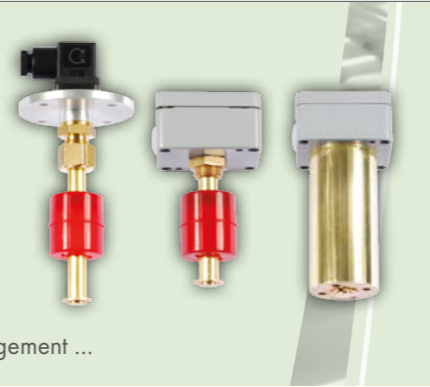

Application: e.g. hydraulic machinery, mechanical engineering, liquid management ...

ANALOG LEVEL MEASUREMENT WITH REED CHAIN

- Different kinds of electrical connections and mountings
- Output signal 0 - 10 V or 4 - 20 mA
- Resolution from 2.5 mm to 10 mm



Application: e.g. mechanical engineering, liquid management, power station, water treatment, hydraulic machinery, galvanizing ...

FLOAT SWITCH STAINLESS STEEL

- A variety of electrical connections selectable
- Different possibilities of mounting (stainless steel or aluminium)
- Sliding tube made of stainless steel
- Float made of stainless steel
- Operating temperature up to 150 °C
- Up to 5 switching points, according to customer requirement



Application: e.g. mechanical engineering, liquid management, food industry, water treatment ...

ANALOG LEVEL MEASUREMENT MAGNETOSTRICTIVE

- High resolution < 0.1 mm
- Different kinds of electrical connections and mountings
- Material e.g. PP, PVDF, PVC
- Output signal 0 - 10 V or 4 - 20 mA



Application: e.g. mechanical engineering, liquid management, power station, water treatment, hydraulic machinery, medicine ...

FLOAT SWITCH PLASTIC

- Mounting, sliding tube and float switch made of one of the following materials: PVC, PP, PVDF, ECTFE, Teflon
- Various electrical connections selectable
- Up to 5 switching points, according to customer requirement

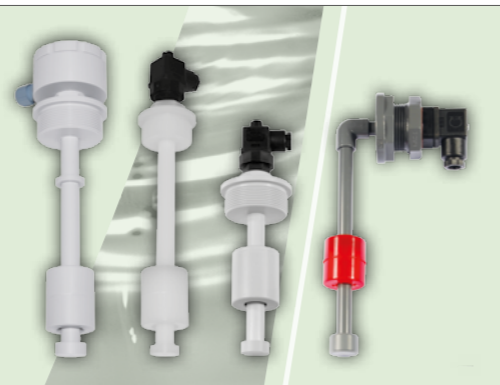

Application: e.g. mechanical engineering, liquid management, plant engineering, galvanizing ...

FLOAT SWITCH WITH TEMPERATURE SWITCH

- Temperature switch in combination with bimetal switch
- Different kinds of electrical connections and mountings
- Sliding tube made of stainless steel or plastics
- Up to five level switching points according to customer requirement



Application: e.g. hydraulic machinery, mechanical engineering, liquid management ...

MINI FLOAT SWITCH

- Small and solid design
- Different kinds of electrical connections and mountings (e.g. screw thread connection, flange)
- Sliding tube made of brass or stainless steel (8 mm diameter)
- Up to three switching points according to customer requirement



Application: e.g. hydraulic machinery, mechanical engineering, liquid management ...

FLOAT SWITCH WITH TEMPERATURE SENSOR

- In combination with temperature sensor, e.g. PT100, PT500, PT1000
- Different kinds of electrical connections and mountings
- Sliding tube made of stainless steel or plastics
- Up to five level switching points according to customer requirement

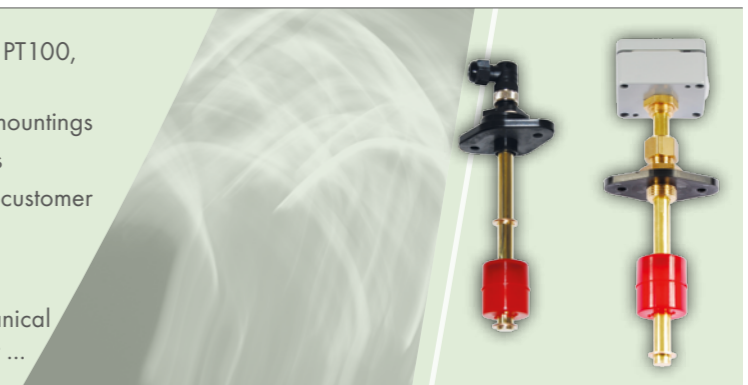

Application: e.g. hydraulic machinery, mechanical engineering, liquid management ...

FLOAT SWITCH WITH ANALOG TEMPERATURE MEASUREMENT

- In combination with temperature output signal of 0 - 10 V or 4 - 20 mA
- Sliding tube made of brass or stainless steel
- Up to five level switching points according to customer requirement

Application: e.g. hydraulic machinery, mechanical engineering, liquid management ...

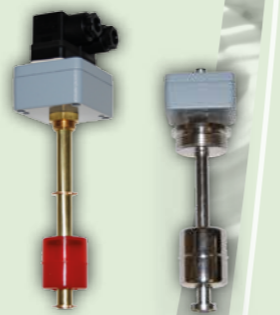

TEMPERATURE SENSOR WITH AND WITHOUT ANALOG OUTPUT SIGNAL

- Different kinds of sensors, e.g. PT100, PT500, PT1000, PTC, NTC
- Various electrical connections
- Analog output signal, options 0 - 10 V or 4 - 20 mA
- Different kinds of application in regards to different temperatures
- Various possibilities of mountings
- Different materials for sliding tube and mounting

Application: e.g. hydraulic machinery, mechanical engineering, liquid management, medical engineering, food industry ...

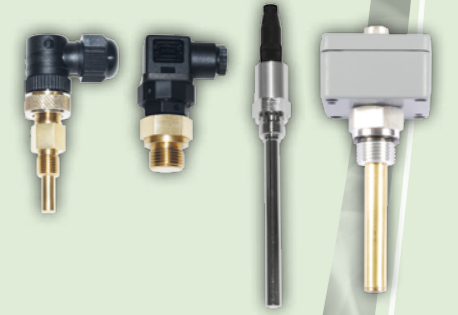

FLOAT SWITCH WITH ELECTRONIC TEMPERATURE CONTROLLER

- In combination with electronic temperature control
- Offers up to six relay outputs for temperature and level
- Wide range of electrical connections
- Set up of hysteresis
- Level switching points according to customer requirement

Application: e.g. hydraulic machinery, mechanical engineering, liquid management ...

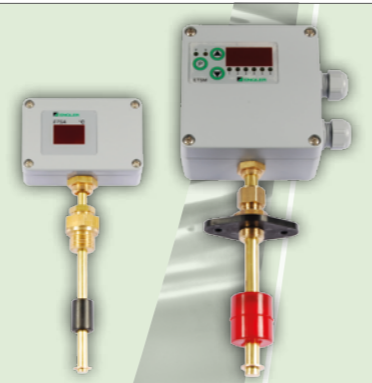

MEASURING TRANSDUCER/ DISPLAY AND CONTROL INSTRUMENTS

Measuring transducer:
· Measuring transducer for level and temperature, operating voltage 24 VDC, analog output signal, options 0 - 10 V or 4 - 20 mA, cap rail housing

Display and control instruments:
· Display and evaluation instruments up to four relay outputs, optional with adjustment of parameters, optional R 232 interface, electrical power supply selectable (24 VDC, 110 VAC or 230 VAC), Display of set point (desired value/actual value)

Sensor entry: diverse physical dimensions selectable, e.g. level, temperature, pressure ...



ANALOG TEMPERATURE AND LEVEL MEASUREMENT REED CHAIN

- Combination of level and temperature control selectable
- Wide range of electrical connections and mountings
- Resolution as from 2,5 mm upwards
- Sliding tube made of brass, stainless steel or plastics with a diameter of 8 mm or 12 mm
- Analog output signal, options 0 - 10 V or 4 - 20 mA for level and temperature

Application: e.g. hydraulic machinery, mechanical engineering, liquid management ...

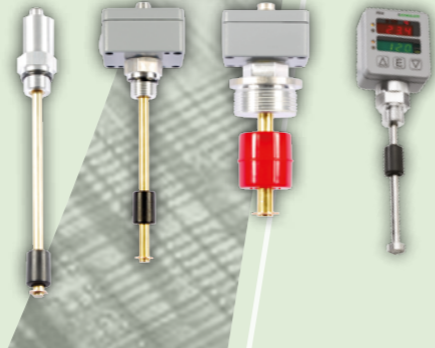

TEMPERATURE SWITCH

- Different kinds of switches selectable e.g. bimetallic switch, electronic switch, temperature switch
- Wide range of electrical connections and mountings
- Different materials for sliding tube and mounting

Application: e.g. hydraulic machinery, mechanical engineering, medical engineering, food industry, liquid management ...

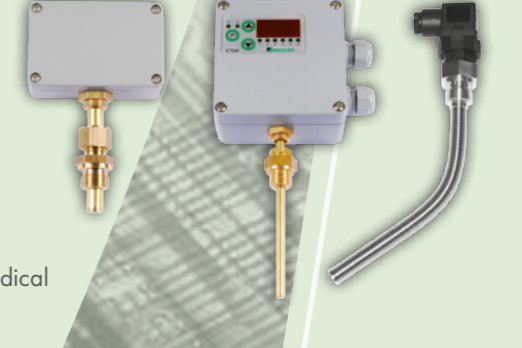

SPECIAL-PURPOSE SOLUTIONS

1. Float switch with control unit
2. Level and temperature sensor with external electronic analysis
3. Level sensor with pneumatic switch
4. Level controller made of PP material



PRESSURE MEASURING CONTROLLER

The pressure controller is a compact integration of pressure switch, pressure sensor and display instrument. It provides all for a perfect pressure monitoring and pressure control for hydraulic and pneumatic systems, especially within permanent serial applications.



LEVEL MONITORING FOR BY-PASS AND EXTERNAL MOUNTING

- Monitoring by switch or by analog controller
- Different designs with or without gauge-glass
- Optionally with digital display
- Wide range of selectable materials for sliding tube and mountings



SUCTION PANEL WITH AND WITHOUT LEVEL MONITORING

- Made of stainless steel; other materials are possible according to customer requirement
- Combination of level and temperature monitoring selectable
- Wide range of selectable materials for sliding tube and mountings
- Integrated ball valve



FLOAT SWITCH WITH INTEGRATED CONTROL SYSTEM

- Diverse functions adjustable
- In combination with ENGLER- float switch design 1, 3 and 7
- Application: typically for pump control



COMPETENCE CENTER

As your partner we provide:

- Development and construction according to customer requirement up to series-production
- Commission processing in electrics, electronics, mechanics, laser welding, mounting of components
- Manufacturing of prototypes, small series production and line production
- Complete manufacturing process, from conception to quality management up to packaging management

Our passion: Control. Measure. Regulate.

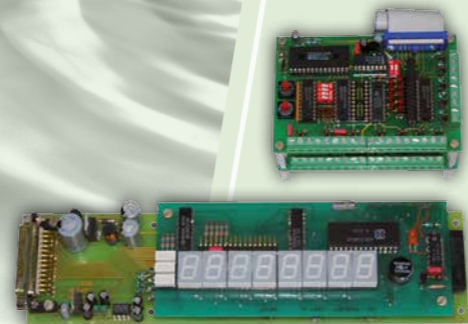

Equipments for explosion protection in intrinsically safe circuits [Ex i]



UniExSS: FLOAT SWITCH IN STAINLESS STEEL FOR ALL AREAS

- Different possibilities of mounting selectable in stainless steel or aluminium
- A variety of electrical connections available
- Up to 5 switching points, according to customer requirement
- Combinable with Temperature sensor or temperature switch

Application: e.g. processes with liquid media in areas with potentially explosive atmosphere, Zone 0/1, II 1/2 G Ex ia IIC T3...T6 Ga/Gb

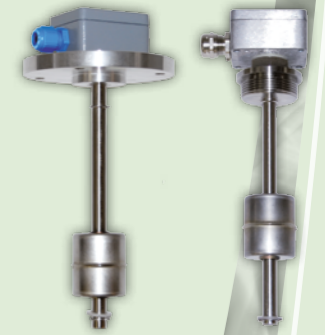

UniExM: MINI FLOAT SWITCH COMPACT DESIGN

- A variety of electrical connections
- A wide range of mounting via threads or flanges available in stainless steel or aluminium
- 8 mm diameter tube
- Max. 3 switching points, according to customer specification
- Combinable with Temperature measurement

Application: e.g. processes with liquid media in areas with potentially explosive atmosphere, Zone 0/1,1 and 2



UniExANM: ANALOGUE LEVEL HIGH MEASURING PRECISION

- With ATEX-compliant analogue output 0 - 10 V or 4 - 20 mA
- For level and temperature measurement combined
- Small resolutions as from 2.5mm
- All typical industrial mountings available in stainless steel or aluminium

Application: e.g. processes with liquid media in areas with potentially explosive atmosphere, Zone 0/1,1 and 2



UniExT: TEMPERATURE MEASUREMENT LARGE PRODUCT VARIETY

- Various types of sensors e.g. PT100, PT1000
- Bimetal switch with a precision of ± 3 °C
- Different types of electrical connections and mountings

Application: for various media e.g. liquids, vapours, gas, pastes, ..., Zone 0/1,1 and 2





ENGLER Steuer- und Messtechnik
GmbH & Co. KG
Lange Straße 151
D-72535 Heroldstatt

Phone +49 (0) 73 89 / 90 92-0
Fax +49 (0) 73 89 / 90 92-40

mail: info@engler-msr.de
www.engler-msr.de

